

FUJIWELD

フジ ウェルディング イクイップメント

SPOT WELDING



 www.indotara.co.id



HIGH QUALITY



SAVE ENERGY



EASY OPERATION

TABLE OF CONTENT

Capacitor Discharger Spot Welding Machine	01-04
Medium Frequency Inverter Spot Welding Machine	05-08
Pneumatic AC Pulse Spot Welding Machine	09-12
Secondary Rectifying Spot Welding Machine	13-14
Suspension Portable Spot Welding Machine	15-16
Foot Pedal Type Spot Welding Machine	17
Desktop High Precision Spot Welding Machine	18-19
Automatic Feeding Spot Welding Machine	20-21

CAPACITOR DISCHARGER

SPOT WELDING MACHINE

Capacitance energy storage spot welding machine is the use of capacitance energy storage and instantaneous release of current, at the same time, the concentration of large current through small points when the fusion effect (welding process in It's done in a few thousandths of a second, with thousands of amperes flowing in between).

FUJiWELD
フジ ウェルディング イクイップメント



HIGH QUALITY



SAVE ENERGY



EASY OPERATION

CAPACITOR DISCHARGER

SPOT WELDING MACHINE

Mainly used in copper, stainless steel, silver, nickel alloy materials, as well as the welding between different metals. It is widely used in the fields of industrial production and manufacturing, such as construction, automobile, hardware, furniture, household appliances, kitchen appliances, motorcycle accessories, toys, lighting, and microelectronics, glasses, etc.

FUJIIWELD
フジ ウェルディング イクイップメント



FJW-C-2K

Digital Dial Code Type



FJW-C-2K

Touchscreen



FJW-C-2K

Intelligent Microcomputer

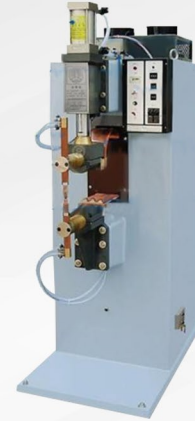

FJW-C-3K

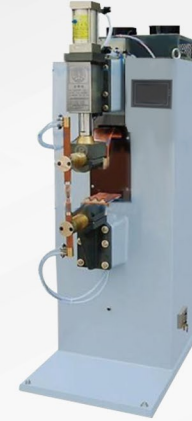

FJW-C-3K

Touchscreen



FJW-C-5K



FJW-C-7K



FJW-C-10K



FJW-C-15K

Touchscreen

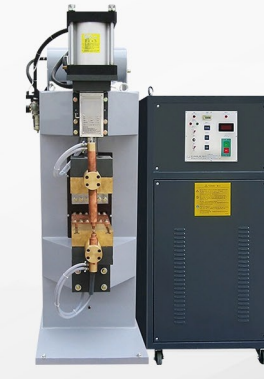

FJW-C-18K/20K

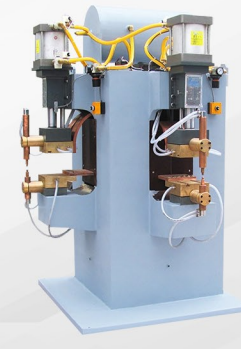

FJW-C-18K

Touchscreen



FJW-C-25K

CAPACITOR DISCHARGER

SPOT WELDING MACHINE

Mainly used in copper, stainless steel, silver, nickel alloy materials, as well as the welding between different metals. It is widely used in the fields of industrial production and manufacturing, such as construction, automobile, hardware, furniture, household appliances, kitchen appliances, motorcycle accessories, toys, lighting, and microelectronics, glasses, etc.

FUJIWELD
フジ ウェルディング イクイップメント



FJW-C-30K

Large Power Capacitor Discharge
Spot Welding Machine



FJW-C-40K

Refrigerator Compressor Three
Station Spot Welding Machine



FJW-C-50K

Automobile Gas Storage Tank
End Cap Nut Welding Machine



FJW-CD-2K

Single slide Double
Point Welding



FJW-CD-2K

Double slide Double
Point Welding



FJW-CD-3K



FJW-CD-15K

Stainless Steel Pan Handle
Spot Welding Machine



FJW-CD-18K

Non Stick Coating
Spot Welding Machine



FJW-CD-20K



FJW-CD-45k

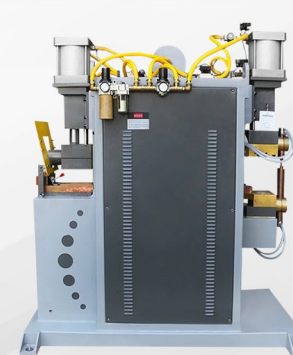

FJW-C/CD-25K

Non Stick Coating Pan Handle Spot Welding Machine



CAPACITOR DISCHARGER

SPOT WELDING MACHINE

Mainly used in copper, stainless steel, silver, nickel alloy materials, as well as the welding between different metals. It is widely used in the fields of industrial production and manufacturing, such as construction, automobile, hardware, furniture, household appliances, kitchen appliances, motorcycle accessories, toys, lighting, and microelectronics, glasses, etc.

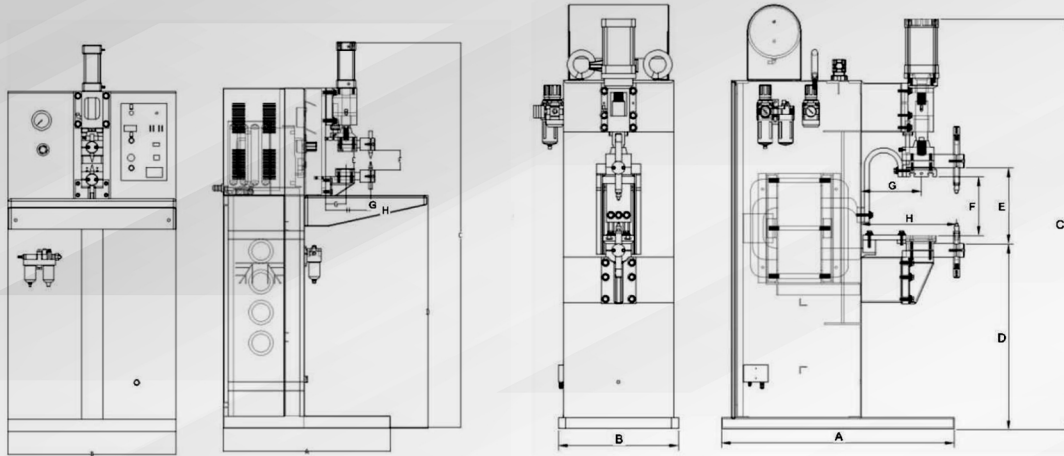

Exterior Assembly Diagram

Model	Voltage V	Power KVA	Output Heat W.S	Capacitance UP	Electrode Force KG	Electrode Stroke mm	Overall Dimension A mm	Overall Dimension B mm	Overall Dimension C mm	Overall Dimension D mm	Overall Dimension E mm	Overall Dimension F mm	Overall Dimension G mm	Overall Dimension H mm
FIW-C-1K	220 1PH	1	300	3000	30	25	545	550	1250	760	58	65	68	150
FIW-C-2K	220 1PH	2	500	4500	100	50	545	550	1250	760	58	65	68	150
FIW-C-2.5K	220 1PH	2.5	1000	9000	100	50	545	550	1250	760	58	65	68	150
FIW-C-3K	380 3PH	3	1500	14000	350	80	950	590	1580	790	250	205	245	370
FIW-C-5K	380 3PH	5	3000	28000	350	80	700	390	1570	770	270	225	245	390
FIW-C-7K	380 3PH	7	4500	42000	800	100	950	490	1675	758	310	240	245	390
FIW-C-10K	380 3PH	10	6000	60000	1000	100	950	490	1670	740	320	240	330	460
FIW-C-12K	380 3PH	12	7000	70000	1000	100	950	490	1670	740	320	240	330	460
FIW-C-15K	380 3PH	15	8000	80000	1000	100	950	490	1670	740	320	240	330	460
FIW-C-18K	380 3PH	18	10000	100000	1500	100	950	490	1670	740	320	240	330	460
FIW-C-20K	380 3PH	20	15000	150000	1500	100	950	490	1670	740	320	240	330	460
FIW-C-25K	380 3PH	25	18000	180000	2000	100	950	600	1670	740	320	240	330	460
FIW-C-30K	380 3PH	30	20000	200000	2000	100	1100	600	1670	740	320	240	330	460
FIW-C-40K	380 3PH	40	25000	250000	2000	100	1100	600	1670	740	320	240	330	460
FIW-C-50K	380 3PH	50	30000	300000	2000	100	1100	600	1670	740	320	240	330	460
FIW-C-60K	380 3PH	60	35000	350000	2000	100	1100	600	1670	740	320	240	330	460

Part Of Welding Sample



MEDIUM FREQUENCY INVERTER

SPOT WELDING MACHINE

The medium frequency inverter spot welding machine can rectify three-phase AC to DC and DC inverters into medium frequency 1000Hz square wave through the inverter circuit composed of IGBT. Then medium frequency 1000Hz square wave is connected into the primary of welding transformer, and the welding transformer make it with lower voltage and rectify it to be a dc supply electrode with little pulsation to the electrodes to weld the work piece. The inverter can adjust the duty ratio of IGBT by feedback the primary or secondary welding current, so as to achieve the effect of constant current in the welding process.

FUJiWELD

フジ ウェルディング イクイップメント



HIGH QUALITY



SAVE ENERGY



EASY OPERATION

MEDIUM FREQUENCY INVERTER

SPOT WELDING MACHINE

For copper, aluminum, nickel, molybdenum, tungsten, manganese, gold, silver and other non-ferrous metal welding. Widely used in low carbon steel plate, stainless steel plate, galvanized sheet, aluminum plate, wire welding, multipoint projection welding, the automobile manufacturing industry of high strength steel, steel spot welding, nut projection welding, as well as the high and low voltage electrical industry welding of copper, silver contact and copper sheet.

FUJIWELD
フジ ウェルディング イクイップメント



FJW-MF-5K



FJW-MF-5K



FJW-MF-10K/50K



FJW-MF-15K/50K



FJW-MF-75K/120K



FJW-MF-160K/250K

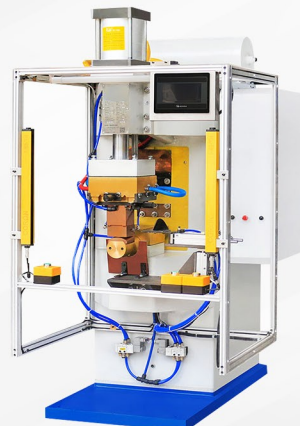

FJW-MF-300K

Water Kettle Spout Medium
Frequency Spot Welding Machine



FJW-MF-400K/500K

Conductor Wire Terminal Medium
Frequency Spot Welding Machine



FJW-MF-25K



FJW-MF-75K

Touchscreen

MEDIUM FREQUENCY INVERTER

SPOT WELDING MACHINE

For copper, aluminum, nickel, molybdenum, tungsten, manganese, gold, silver and other non-ferrous metal welding. Widely used in low carbon steel plate, stainless steel plate, galvanized sheet, aluminum plate, wire welding, multipoint projection welding, the automobile manufacturing industry of high strength steel, steel spot welding, nut projection welding, as well as the high and low voltage electrical industry welding of copper, silver contact and copper sheet.

FUJIIWELD
フジ ウェルディング イクイップメント

FEATURE

- The current in secondary welding loop is DC, Dramatically reduce the impact to the welding current due to the inductive reactance in secondary loop when conducting welding to the work piece.
- Three-phase balanced load can reduce the requirement to the power supply system. The power factor is close to 1, No electrical inductance, so no need to adjust the power factor.
- Eradicate the contamination to the power supply, It is a kind of environmentally friendly welding method, No need to provide power independently, It is able to be used together with robotic welding system.
- Reduce power consumption, energy saving, Reduce the requirement of cables and lots of maintenance cost.
- The weight of transformer is reduced greatly, It is light and convenient, The weight and size of the MF transformer is only 1/3 of the AC type transformer, Suitable for robot welding system.
- Increase the heat input efficiency, The output of welding transformer is DC voltage, without the disturbance of inductance, Pure DC has no defect of zero passage, The efficiency of heat is enhanced dramatically.
- Intelligent digital full-closed loop control, The welding control current will be more precise, The adjustment precision and monitoring precision is 20 times higher than the AC system, Be able to protect the inverter and transformer.
- Increase the stability of the welding technology, DC welding technology is good and the welding parameters are of wide application, The secondary current could achieve actual constant current, Have better using prospect than AC.
- Digital control can better improve the current control and measurement accuracy, The welding time precision is ms which can help you control the welding time at random.
- Be able to weld aluminum and galvanized metal with good welding quality.
- Especially suitable for welding three-layer metal sheet or very thin material and precision welding requirement.
- Precision inverter DC resistance welding, Higher inverter frequency, more accurate control of the current.

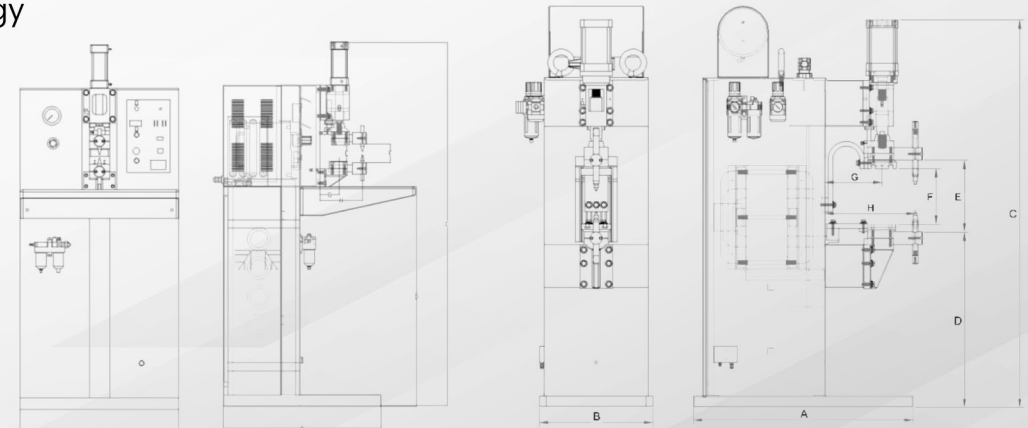

Exterior Assembly Diagram

MEDIUM FREQUENCY INVERTER

SPOT WELDING MACHINE

For copper, aluminum, nickel, molybdenum, tungsten, manganese, gold, silver and other non-ferrous metal welding. Widely used in low carbon steel plate, stainless steel plate, galvanized sheet, aluminum plate, wire welding, multipoint projection welding, the automobile manufacturing industry of high strength steel, steel spot welding, nut projection welding, as well as the high and low voltage electrical industry welding of copper, silver contact and copper sheet.



Model	Voltage V	Rated Capacity KVA	Max Short Circuit Current	Duty Cycle Rate %	Electrode Force KG	Electrode Stroke mm	Cooling Water L/min	Overall Dimension A mm	Overall Dimension B mm	Overall Dimension C mm	Overall Dimension D mm	Overall Dimension E mm	Overall Dimension F mm	Overall Dimension G mm	Overall Dimension H mm
FJW-MF-5K	380 3PH	5	1.5	50	30	25	10	545	550	1250	760	58	65	68	150
FJW-MF-10K	380 3PH	10	3	50	100	50	20	545	550	1250	760	58	65	68	150
FJW-MF-15K	380 3PH	15	4.5	50	100	50	20	545	550	1250	760	58	65	68	150
FJW-MF-25K	380 3PH	25	7.5	50	350	80	20	700	390	1570	765	275	225	255	390
FJW-MF-35K	380 3PH	35	10	50	350	80	20	700	390	1570	765	275	225	255	390
FJW-MF-50K	380 3PH	50	13	50	800	100	30	950	490	1675	758	310	240	245	390
FJW-MF-75K	380 3PH	75	18	50	800	100	30	950	490	1675	758	310	240	245	390
FJW-MF-100K	380 3PH	100	21	50	1000	100	30	950	490	1675	758	310	240	245	390
FJW-MF-120K	380 3PH	120	23	50	1000	100	30	950	490	1675	758	310	240	245	390
FJW-MF-160K	380 3PH	160	28	50	1000	100	30	950	490	1675	758	310	240	245	390
FJW-MF-200K	380 3PH	200	32	50	1500	100	30	950	490	1675	758	310	240	245	390
FJW-MF-250K	380 3PH	250	40	50	1500	100	50	950	600	1675	758	310	240	245	390
FJW-MF-300K	380 3PH	300	48	50	2000	100	50	950	600	1675	758	310	240	245	390
FJW-MF-350K	380 3PH	350	55	50	2000	100	60	950	800	1675	758	310	240	245	390
FJW-MF-400K	380 3PH	400	62	50	2000	100	60	950	600	1675	758	310	240	245	390
FJW-MF-500K	380 3PH	500	70	50	2000	100	60	950	800	1675	758	310	240	245	390

Part Of Welding Sample



PNEUMATIC AC PULSE

SPOT WELDING MACHINE

AC pulse spot welder utilizes the general mains supply to lower the voltage and increase the electric current. Such kind of low voltage but large current will be transmitted from the electrode to the linked point of two work pieces. On the linkage, due to the resistance of work piece, high temperature will occur so the metal will therefore generate high heat to make the work pieces in molten condition. Thus, the purpose of welding the two work pieces is achieved.

FUJIIWELD
フジ ウェルディング イクイップメント



HIGH QUALITY



SAVE ENERGY



EASY OPERATION

PNEUMATIC AC PULSE

SPOT WELDING MACHINE

Suitable for spot welding or projection welding of steel plate and stainless steel sheet. Iron wire products, hardware decorative lighting, kitchen utensils, automobile industry, small household appliances, small hardware, etc.

FUJIWELD
フジ ウェルディング イクイップメント



FJW-S-10K/25K

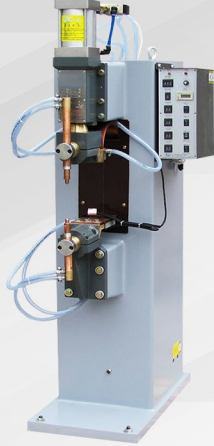

FJW-S-25K/35K/50K

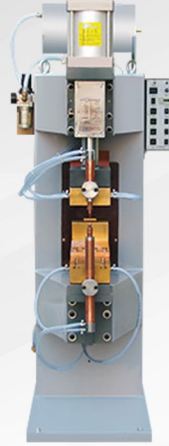

FJW-S-75K/100K/150K



FJW-S-10K/25K

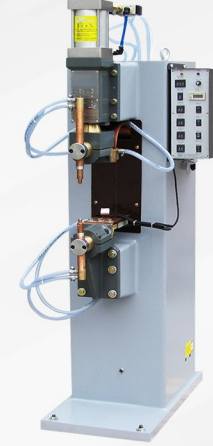

FJW-S-25K/35K/50K

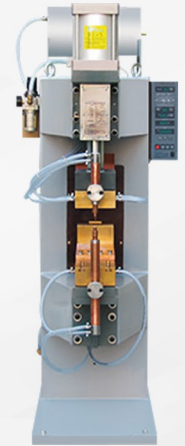

FJW-S-75K/100K/150K



FJW-SP-200K/250K



FJW-SP-300K



FJW-SP-25K
Japan MIYACHI Controller



FJW-SP-25K
Long Copper Rod



FJW-SP-50K
Long Arm

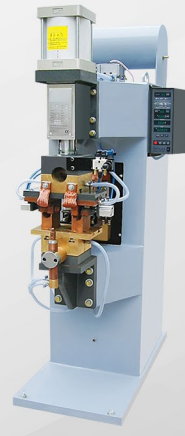

FJW-SP-75K
Lockset Spot Welding Machine

PNEUMATIC AC PULSE

SPOT WELDING MACHINE

Suitable for spot welding or projection welding of steel plate and stainless steel sheet. Iron wire products, hardware decorative lighting, kitchen utensils, automobile industry, small household appliances, small hardware, etc.

FUJIWELD

フジ ウェルディング イクイップメント



FJW-S-10K/25K



FJW-S-25K/35K/50K

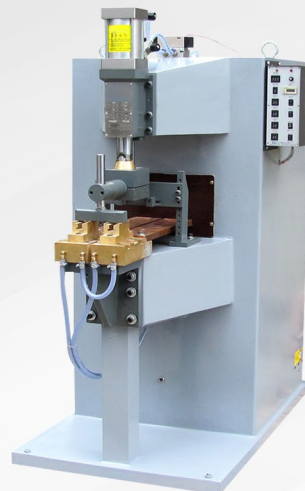

FJW-S-75K/100K/150K



FJW-S-10K/25K

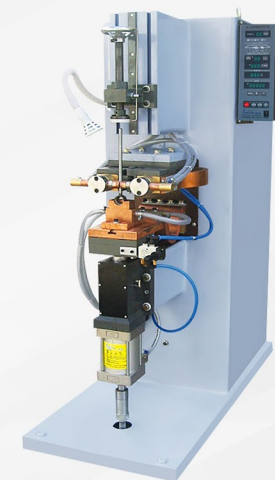

FJW-S-25K/35K/50K

Part Of Welding Sample

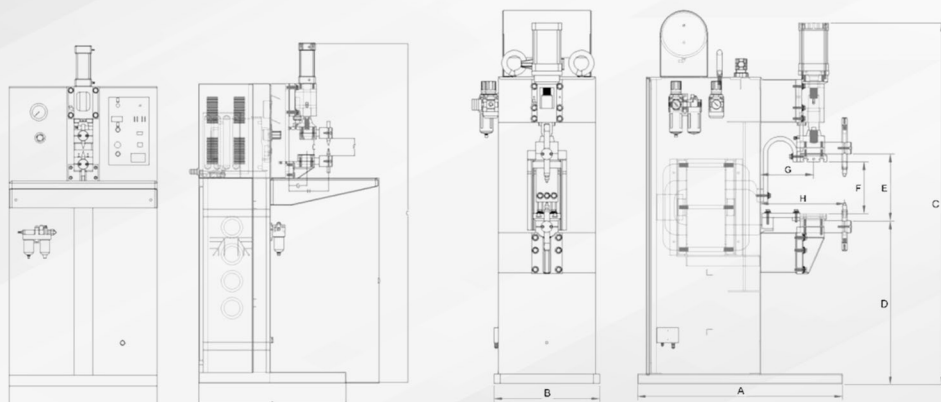

Part Of Welding Sample



PNEUMATIC AC PULSE

SPOT WELDING MACHINE

Suitable for spot welding or projection welding of steel plate and stainless steel sheet. Iron wire products, hardware decorative lighting, kitchen utensils, automobile industry, small household appliances, small hardware, etc.

FUJIIWELD
フジ ウェルディング イクイップメント

Model	Voltage V	Rated Capacity KVA	Max Short Circuit Current	Duty Cycle Rate %	Electrode Force KG	Electrode Stroke mm	Cooling Water L/min	Overall Dimension A mm	Overall Dimension B mm	Overall Dimension C mm	Overall Dimension D mm	Overall Dimension E mm	Overall Dimension F mm	Overall Dimension G mm	Overall Dimension H mm
FJW-S-5K	220	5	1	25	30	25	4	545	550	1250	760	58	65	68	150
FJW-S-10K	380 1PH	10	2.5	25	100	50	4	545	550	1250	760	58	65	68	150
FJW-S-16K	380 1PH	16	4.5	25	100	50	6	555	550	1260	760	58	60	68	150
FJW-SP-25K	380 1PH	25	7	25	350	80	6	700	390	1570	770	270	225	245	390
FJW-SP-35K	380 1PH	35	9	25	350	80	6	700	390	1570	770	270	225	245	390
FJW-SP-50K	380 1PH	50	13	25	800	100	6	950	490	1675	758	310	240	245	390
FJW-SP-75K	380 1PH	75	18	25	1000	100	8	950	490	1680	760	310	235	300	465
FJW-SP-100K	380 1PH	100	20	25	1000	100	8	950	490	1680	755	315	235	335	465
FJW-SP-150K	380 1PH	150	25	25	1000	100	8	950	490	1680	745	315	235	335	465
FJW-SP-200K	380 1PH	200	30	25	1500	100	10	950	550	1680	745	315	235	335	465
FJW-SP-250K	380 1PH	250	38	25	1500	100	12	950	550	1680	745	315	235	335	465
FJW-SP-300K	380 1PH	300	45	25	2000	100	16	950	600	1680	745	315	235	335	465

Part Of Welding Sample



HIGH QUALITY



SAVE ENERGY



EASY OPERATION

SECONDARY RECTIFYING

SPOT WELDING MACHINE

Secondary rectifying spot welder under the welding transformer secondary with high-power silicon diode rectifier group. transform AC current into DC current for welding work piece. Adopts welding frame structure which is formed after processing through stress relieving of aging treatment. High intensity, low deformation. Good rigidity in anti-vibration and anti-shock which can help to achieve stable welding and prevent electrode tip from slipping during pressurization.

FUJiWELD

フジ ウェルディング イクイップメント



FJW-SZ-50Kx3



FJW-SZ-75Kx3



FJW-SZ-150Kx3



HIGH QUALITY



SAVE ENERGY



EASY OPERATION

SECONDARY RECTIFYING

SPOT WELDING MACHINE

suitable for spot welding or projection welding of steel plate and stainless steel sheet. Iron wire products, hardware decorative lighting, kitchen utensils, automobile industry, small household appliances, small hardware, etc.



Model	FJW-SZ-75Kx3	FJW-SZ-80Kx3	FJW-SZ-100Kx3	FJW-SZ-150Kx3
Max Welding Thickness	4+4 Low Carbon Steel 3+3 Stainless Steel 2.8+2.8 Aluminium Alloy 1.5 + 1.5 Brass	4+4 Low Carbon Steel 3.5+3.5 Stainless Steel 3.2+3.2 Aluminium Alloy 2 + 2 Brass	5+5 Low Carbon Steel 4+4 Stainless Steel 3.5+3.5 Aluminium Alloy 3 + 3 Brass	6+6 Low Carbon Steel 5+5 Stainless Steel 4+4 Aluminium Alloy 3.5 + 3.5 Brass
Input Power	Three-Phase Four-Wire			380V±10% 50Hz
Rated Capacity	250KVA	300KVA	350KVA	450KVA
Rated Duty Cycle Rate	50 %			
Max Secondary Floating Voltage	7.6V	8.5V	9V	10.5V
Secondary Max Short Circuit Current	50KA	63KA	65KA	75KA
Controller Program Segment	Prepressing, Preheating, Cooling, Welding, Welding (Forge and Press), Cooling, Tempering, Maintaining, Hold, The Heat of Preheating, Welding and tempering could be adjusted respectively.			
Compensation For power Grid Voltage Fluctuation	When The value of power grid voltage Fluctuates within the range of ±10%, the secondary voltage fluctuates within the range of ≤+3%			
Electrode Arm Length	350mm	400mm	400mm	400mm
Upper Electrode Stroke	80mm ± 50mm			
Projection Welding Platform Dimension	250mm ± 250mm			
Electrode Pressure	0.6Mpa			
Overall Dimension	1800x950x1900mm	2080x950x2250mm	2280x1150x2350mm	2280x1150x2350mm



HIGH QUALITY



SAVE ENERGY



EASY OPERATION

Part Of Welding Sample



SUSPENSION PORTABLE TYPE

SPOT WELDING MACHINE

Suspension portable spot welding machine consist of welding gun, transformer, controller, water cooling system, pneumatic pressurization system, suspension device, etc. Compact structure, small size, light weight, move the welding gun to weld workpiece.

FUJIIWELD
フジ ウェルディング イクイップメント



HIGH QUALITY



SAVE ENERGY



EASY OPERATION

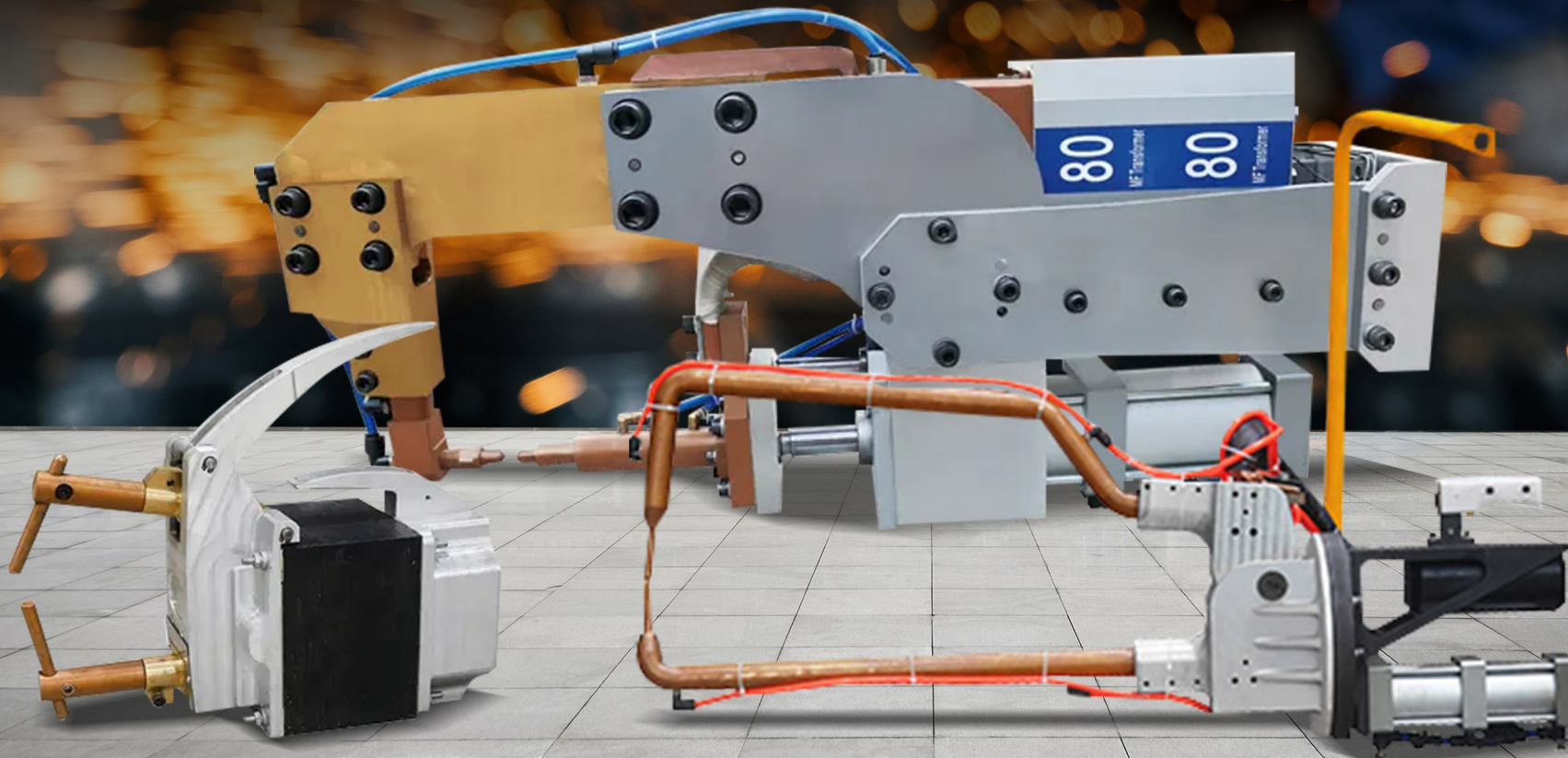

SUSPENSION PORTABLE TYPE



SPOT WELDING MACHINE

This machine is mainly applied to welding low carbon steel, low alloy steel, stainless steel, galvanized steel, sheet metal, etc. and widely used in automobile, commercial sheet metal, security doors, cabinets, household appliances, etc.

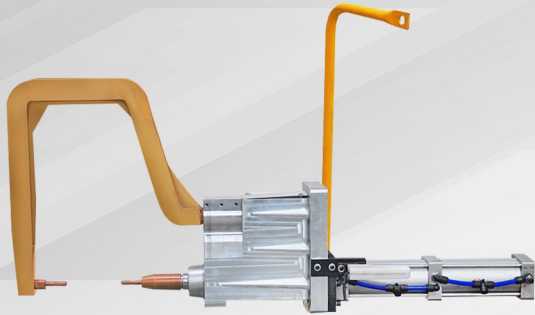

FJW-B-25K

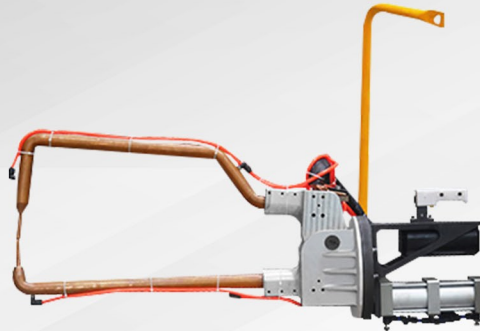

FJW-B-50K

Copper And Aluminum
Butt Welding Machine



FJW-B-200K

Flash Butt Welding Machine



FJW-TB-50K

T Type Butt Welding Machine

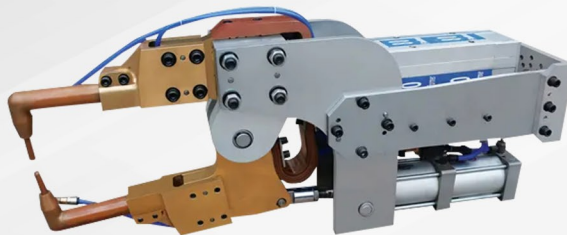

FJW-B-75K

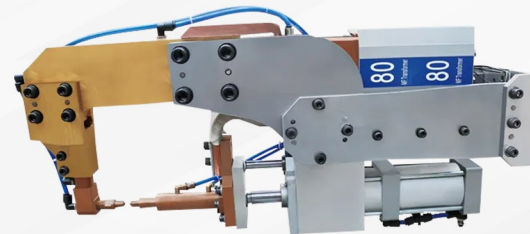

FJW-B-75K

Part Of Welding Sample



HIGH QUALITY



SAVE ENERGY



EASY OPERATION

FOOT PEDAL TYPE

SPOT WELDING MACHINE

Foot pedal spot Welding machine adopts lever pedal spring pressurized structure, easy to operate, with quick response, suitable for a variety of accurate & complicated welding.

Widely used in welding of low carbon steel, stainless steel, aluminum and other metal mesh type, basket, plate material and other hardware crafts.

FUJiWELD
フジ ウェルディング イクイップメント



FJW-FT-16K

FJW-FT-25K

FJW-FT-35K



HIGH QUALITY



SAVE ENERGY



EASY OPERATION

DESKTOP HIGH PRECISION

SPOT WELDING MACHINE

Desktop High Precision spot welding machine is divided into AC type, capacitor type, MF DC type power sources. Using microcomputer control, low pressure welding, stepless adjustment of electrode pressure range and stroke. Flexible with welding head. Be able to choose single-side single-point welding, single-side double-point welding, double-side single-point welding, and double-side double point welding.

FUJiWELD
フジ ウェルディング イクイップメント



HIGH QUALITY



SAVE ENERGY



EASY OPERATION

DESKTOP HIGH PRECISION

SPOT WELDING MACHINE

It is suitable for the welding of fine workpiece such as battery connecting piece, pole ear, leading piece and electrical switch, silver contact, resistance, SMT inductor, coil, sensor, fuse, wire and terminal. Widely used in battery, electronics, instrumentation, low-voltage electrical appliances and other industries.

FUJIWELD
フジ ウェルディング イクイップメント



FJW-S-5K



FJW-S-10K



FJW-B-2K

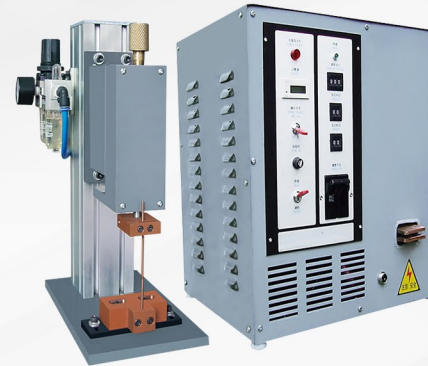

FJW-CJ-1K



FJW-CJD-1K



FJW-CJ-2K



FJW-S-10K



FJW-S-10K

Part Of Welding Sample



HIGH QUALITY



SAVE ENERGY



EASY OPERATION

AUTOMATIC FEEDING

SPOT WELDING MACHINE

Automatic feeding spot welding machine is composed of standard spot welding machine and vibrating plate feeding mechanism, which can realize semi-automatic or automatic welding of workpiece. Various welding power sources such as capacitor discharge, MF DC and AC power can be selected.

FUJiWELD
フジ ウェルディング イクイップメント



HIGH QUALITY



SAVE ENERGY



EASY OPERATION

AUTOMATIC FEEDING

SPOT WELDING MACHINE

Automatic feeding spot welding machine is composed of standard spot welding machine and vibrating plate feeding mechanism, which can realize semi-automatic or automatic welding of workpiece. Various welding power sources such as capacitor discharge, MF DC and AC power can be selected.

FUJiWELD
フジ ウェルディング イクイップメント



FJW-C-2K



FJW-MF-90K

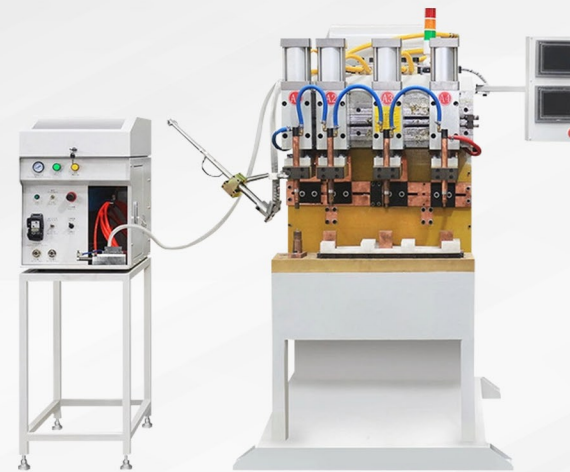

FJW-SQ-MF90K-4

Automatic Nut Transport Spot Welding Machine

Part Of Welding Sample



- The vibration plate equipped with anti- reversal function and low noise design.
- High speed vibration screen sorting function to ensure the delivery speed of nuts.
- Direction of the conveyor rod to increase the guide device, feeding deviation is small, the output is more than 99% accurate.
- Suitable for nuts of four corners. six corners, round shape, M5, M6, M8, M10, M12, 7/16 and other sizes.

INDOTARA®

PT. INDOTARA PERSADA

Our Marketing Office and After Sales Service Center



Head Office

50/F, Menara BCA Grand Indonesia
Jl. M.H. Thamrin No.1,
Jakarta Pusat 10310

021 - 5011 2228
dgc@indotara.id



Semarang Office

Wisma HSBC Lt. 6 suite 609
Jl. Gajah Mada No.135,
Semarang, Jawa Tengah - 50134

024 - 40 300 893
smg.dgc@indotara.id



Bali Office

Benoa Square Lt. 2
Jl. Bypass Ngurah Rai No. 21 A Kedonganan,
Kuta Badung - Bali Indonesia 80361

021 - 5011 2228
bali.dgc@indotara.id



Marketing Office

APL Tower 6th Floor No. 6 Central Park,
Jl. Letjen S. Parman Kav 28,
Jakarta Barat - 11440

021 - 5011 2228
dgc@indotara.id



Medan Office

Sutomo Tower Lantai 5H
Jl. Sutomo Ujung No.28,
Kota Medan, Sumatera Utara 20235

061 - 50 300 595
mdn.dgc@indotara.id



Singapore Office

Marina Bay Financial Centre Tower 3
17F, 12 Marina Boulevard
Singapore - 018982

021 - 5011 2228
sing.dgc@indotara.id



Graha Indotara

Millenium Industrial Estate
Jl. Millenium 22 Blok R3 No. 1,
Cikupa, Tangerang - Banten 15720

021 - 5011 2228
dgc@indotara.id



Makassar Office

Fajar Graha Pena Lt. 5
Jl. Urip Sumoharjo No. 20,
Makassar - Sulawesi Selatan 90234

021 - 5011 2228
mks.dgc@indotara.id



Yogyakarta Office

Hartono Mall Yogyakarta Lt. 3
Kaliwaru, Condongcatur,
Sleman, Yogyakarta 55281

021 - 5011 2228
yog.dgc@indotara.id



Bandung Office

Wisma HSBC Lt. 6 Suite B
Jalan Asia Afrika No.116,
Kota Bandung, Jawa Barat 40112

021 - 5011 2228
bdg.dgc@indotara.id



Balikpapan Office

Panin Tower Lt. 8 Grand Sudirman
Jl. Jendral Sudirman No.7 Klandasan Ilir,
Balikpapan Kota - Kalimantan Timur 76114

021 - 5011 2228
bpp.dgc@indotara.id



Surabaya Office

Japfa Indoland Center, Tower I Lt. 10/1008
Jl. Jendral Basuki Rahmat 129-137
Surabaya 60271

031 - 3360 1491
sby.dgc@indotara.id